







- 
Canalina in estruso di alluminio con diametro equivalente di 160 mm
- 
Extruded aluminium track with equivalent diameter of 160 mm
- 
Rail en aluminium extrudé avec un diametre equivalent de 160 mm
- 
Stanggepresster Alu-Saugschlitzkanal mit DN 160 mm
- 
Carril en aluminio extrudido con diámetro equivalente de 160 mm

Code	Description
GAT1-4	Canalina Estrusa L=4000 mm Øequiv. 160
GAT1-CF	Flangia di chiusura per canalina aerea
GAT1-FFF 160	Flangia di uscita laterale per aspiratore 0.5-1-1.5HP
GAT1-FFD160	Flangia di uscita laterale per tubo Lindab Ø160
GAT-UFC	Materiali di giunzione per canalina aerea
GAT-UFK	Staffa di supporto per GAT1
GAT-UFD160	Flangia di uscita superiore per tubo Lindab Ø160.
GAT-UFD200	Flangia di uscita superiore per tubo Lindab Ø200.
GAT-UFF160	Flangia di uscita superiore con flangia per connessione diretta con aspiratore 0.5-1-1.5 HP
GAT-UFF200	Flangia di uscita superiore con flangia per connessione diretta con aspiratore 2-3 HP

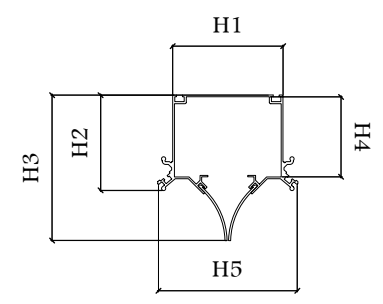
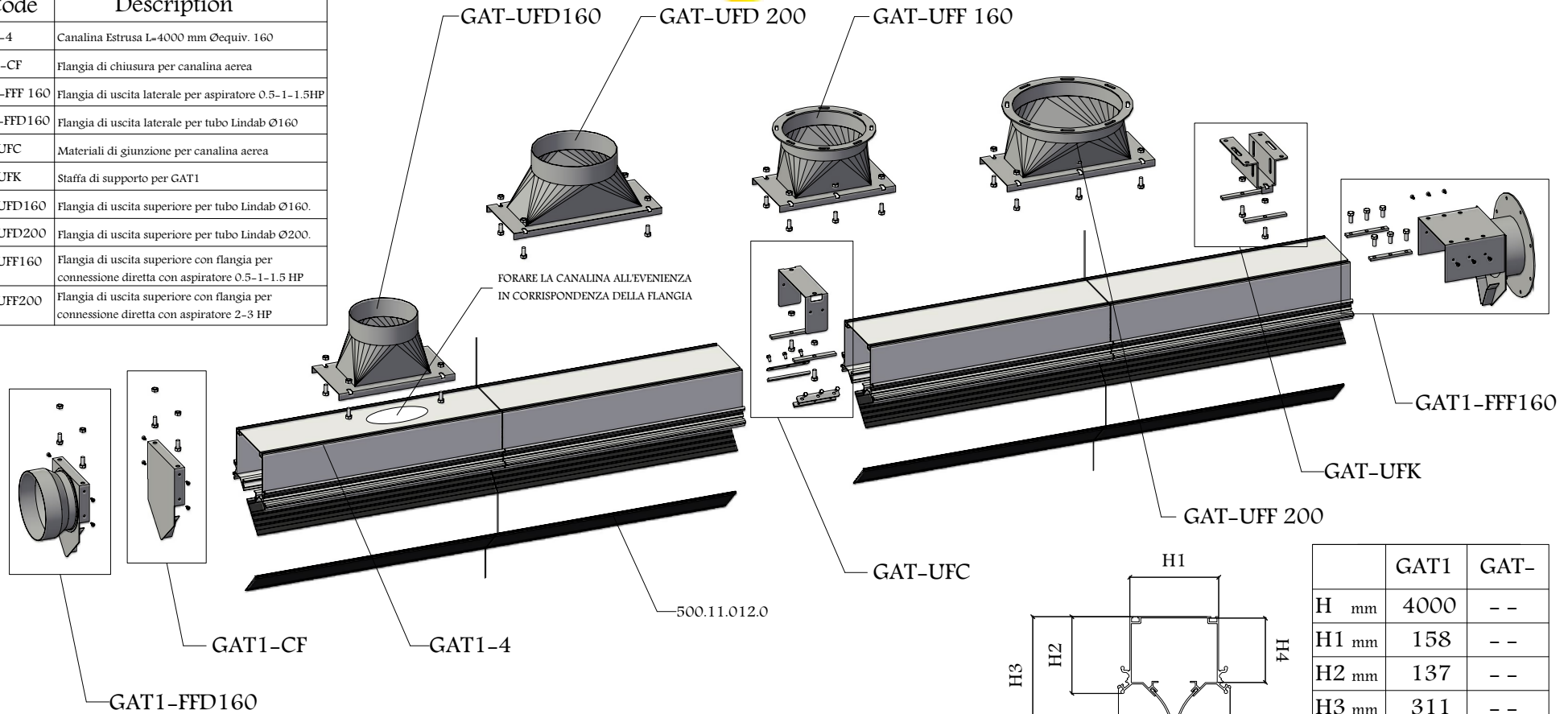

	GAT1	GAT-
H mm	4000	--
H1 mm	158	--
H2 mm	137	--
H3 mm	311	--
H4 mm	115	--
H5 mm	200	--

